









-  LIGHT NEODYMIUM COMPONENTS
-  ASYMMETRICAL DISPERSION HORN
-  VERSATILE FoH PA & STAGE MONITOR
-  REAR PANEL TOUCHSCREEN GUI OPERATION
-  INTEGRATED POWER & CONTROL WITH MULTIPLE PRESETS
-  HIGH RESISTANCE POLYUREA® FINISH & PROTECTIVE RUBBER PROFILES
-  EASY RIGGING & INSTALLATION ACCESSORIES

Two-way design takes a new developmental approach different from its progenitor, the N15, resulting in a new driver and asymmetrical horn, both matched with new levels of operability and performance from the S-series' colour touchscreen operated FIR enhanced, 64-bit DSP control platform.

Improved styling and extra punch enclosed in the same unique low weight / size to high power / output ratio.

KEY FEATURES

TRANSDUCER TECHNOLOGY

Two-way, full range active loudspeaker system comprising a direct radiating 3-inch voice coil, neodymium magnet 15" loudspeaker and one 1.5-inch voice coil diameter, polymer diaphragm neodymium magnet ring HF driver loaded to an asymmetrical rotational horn (50° to 100° x 55° dispersion).

AMPLIFICATION

Onboard 1000 W 3rd generation Class D bi-amplification.

Universal switch mode power supply (SMPS) with Power Factor Correction (PFC), allowing constant power delivery from 85 to 265 VAC input and high efficiency (>90%), with extremely compact lightweight form factor.

Automatic EcoMode low power consumption mode when no signal input present.

Connectors mounted on an inclined, recessed moulded connector plate for improved security and environmental protection.

Double PowerCon® connectors (input & link).

ADVANCED DSP SYSTEM CONTROL

Onboard 64-bit precision DSP loudspeaker system control manages amplifier gain and cross-over settings, peak and thermal limiters and mutes. Includes adjustable 294 ms / 100 m delay line for extensive alignment delay and 5-band fully configurable parametric EQ.

High order FIR filtering ensures fully phase coherent PEQ adjustment and absolute phase alignment of common cabinet coupling.

Extensive R&D'd factory presets provide instantaneous system configuration for common applications, including point-source PA, floor monitoring, speech and subwoofer coupling.

ALC (Adaptive Loudness Compensation) improves the listening experience when the system is used at low volume levels.

Operation and monitoring of system parameters, presets and user-adjustments is via Amate Audio's unique rear-panel 3.5" TFT colour touchscreen GUI. The front-panel NíTiD backlit logo can be switched on or off, or set to indicate system limiting.

DESIGN & ACCESSORIES

Recessed ergonomic carry handles for easy handling.

Asymmetric trapezoidal form for PA or floor monitor application.

Exclusive 1.5mm black mesh speaker grille with optimum perforation gradient and attractive appearance.

Multilayer birch plywood cabinet with Polyurea® coating and protective rubber profiles, providing maximum robustness and strength for touring, events production, venue installation and other highly demanding applications.

M8 rigging points for easy flying.

35mm diameter pole mount socket mounted on the bottom side, for a standard tripod.

TECHNICAL FEATURES

Amplifier (program)	800 W (LF) + 200 W (HF) Class D Bi-amplified	
Input sensitivity	8 dBu – 1.94 V	
Input Impedance	50 kΩ Balanced	
Mains	Universal Switch Mode Power Supply 85-265 V / 45-65 Hz	
Average current draw	1.7 A (Heavy duty musical program)	
SPL(1m)	128 dB musical program, 131 dB peak	
Built-in DSP	64-bit processing unit. Includes factory presets	
AD/DA converters	24 bit – 48 kHz	
Standby mode consumption	3.7 W @230VAC	
Adjustable delay line	294 ms / 100 m	
Crossover frequency	1k5 Hz	
Frequency response (-10dB)	50 Hz – 19 kHz	
Components	LF - MF	15" neodymium woofer (3" voice coil)
	HF	1.5" polymer diaphragm neodymium magnet ring driver
Directivity (-6dB)	50° to 100° (H) x 55° (V)	
Directivity factor (Q)	12.6	
Directivity Index (DI)	11 dB	
Weight	23.8 Kg	
Dimensions (HxWxD)	733 x 423 x 460 mm	
Finish	Multilayer birch plywood with high resistant black Polyurea® coating and protective rubber profiles	
Grille	1.5mm powder coated steel with black acoustic mesh	
Rigging	M8 points	
Connectors	1x XLR input / 1x XLR link / 1x AC PowerCon® input / 1x AC PowerCon® link	

TOUCHSCREEN CONTROL



Amate Audio's latest generation DSP System management is integrated with 3rd generation Class D amplification. Colour touchscreen operation and monitoring of DSP System includes access to powerful presets - engineered by Amate Audio R&D team – that instantly configure your Nítid loudspeaker for the majority of common application environments within seconds, prior to rigging or installation.



TOP VIEW



BOTTOM VIEW

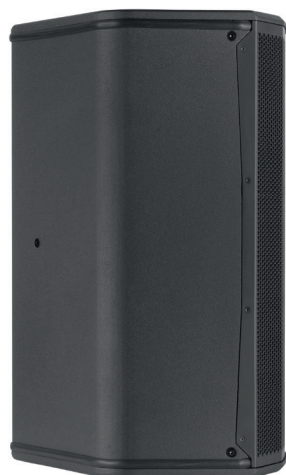

SIDE VIEW



FRONT VIEW



REAR VIEW

FREQUENCY RESPONSE 1w/1m (FLAT PRESET)

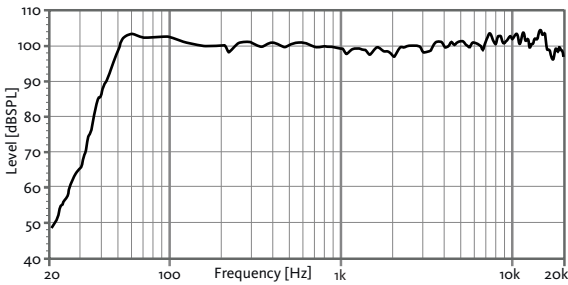

DIRECTIVITY INDEX (DI)

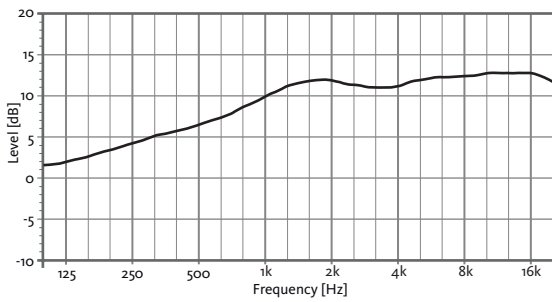

HORIZONTAL & VERTICAL BEAMWIDTH (-6dB point)

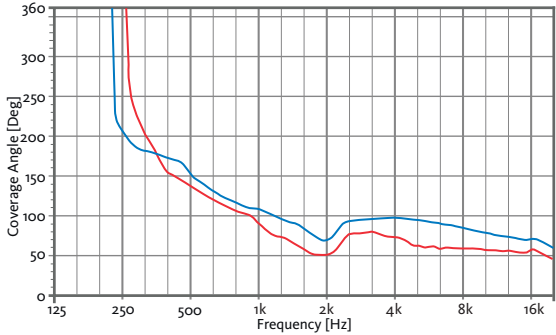

HORIZONTAL VERTICAL

BUILT-IN PRESETS

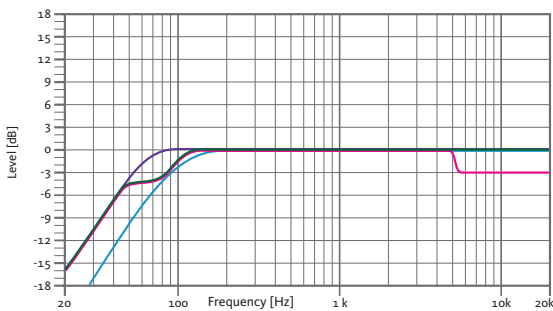

FLAT
Flat response

SPEECH
Vocal use

HPF90
HPF 90 Hz

MONITOR
Stage monitor use

HORIZONTAL COVERAGE

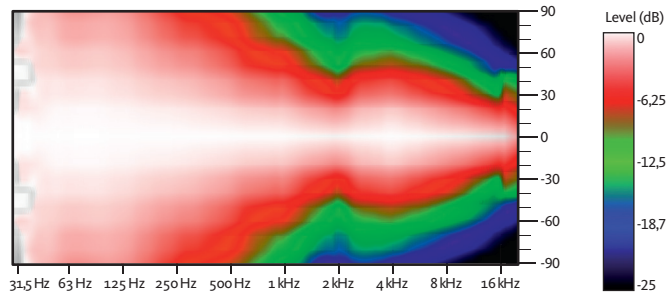

VERTICAL COVERAGE

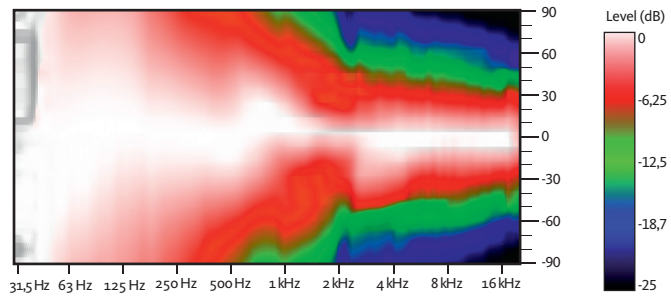

CAD DRAWING SCHEME

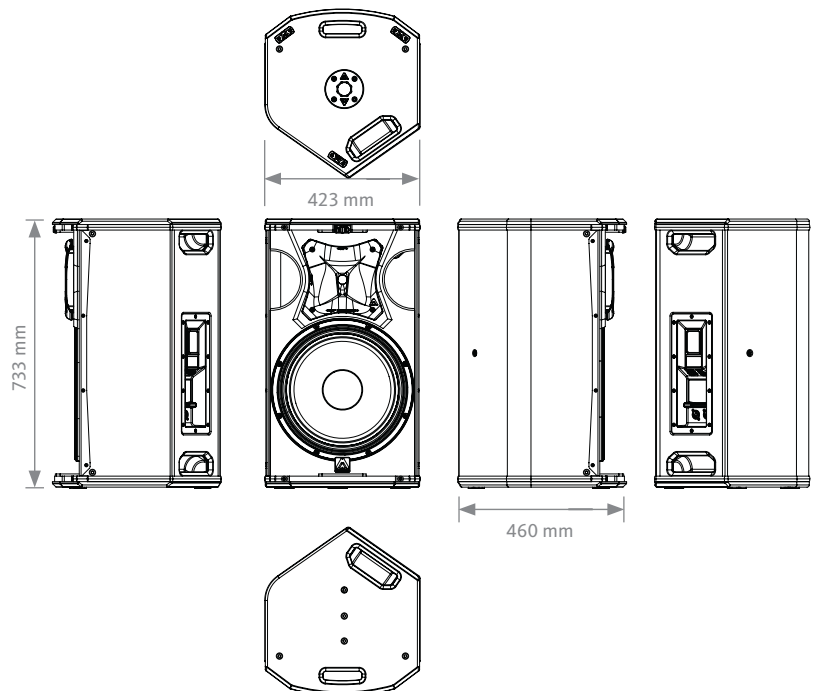

ACCESSORIES

WALL MOUNT BRACKET
UB-L



WALL-MOUNT BRACKET
SP-WHR



FLYING BAR
HR-LU



FLYING BAR WITH HOOK
HR-LU/GT



SAFETY SLING
SC-15



M8 RIGGING EYEBOLT
ACR-M8



FLIGHT CASE
FC-S15
for two units of S15



TELESCOPIC DISTANCE ROD
SP-CRTL
ø: 35 mm
Length:
55 cm ~ 90 cm
Thread: M20



DISCOVER NÍTiD

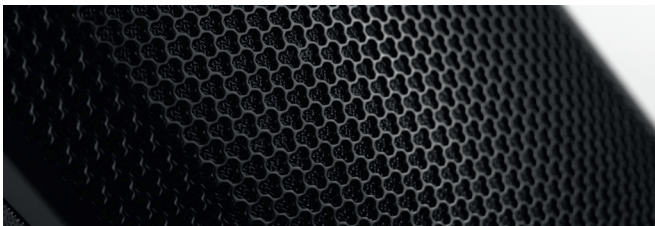

UNIQUE DESIGN

New S-series models build on the success, innovation and best-in-class performance of the original Nítid designs with improved features including a recessed moulded connector plate, more highly stylised form factor and improved robustness of the world's most acoustically transparent pro-audio speaker grille.



THE PERFECT BALANCE

An ongoing programme of research and development ensures that Nítid series loudspeakers continue to achieve the highest levels of output and performance from the most compact sized designs, in an unrivalled synthesis of engineering and aesthetic form.

ASYMMETRICAL DISPERSION HORN

It allows to optimize the coverage depending on its position.

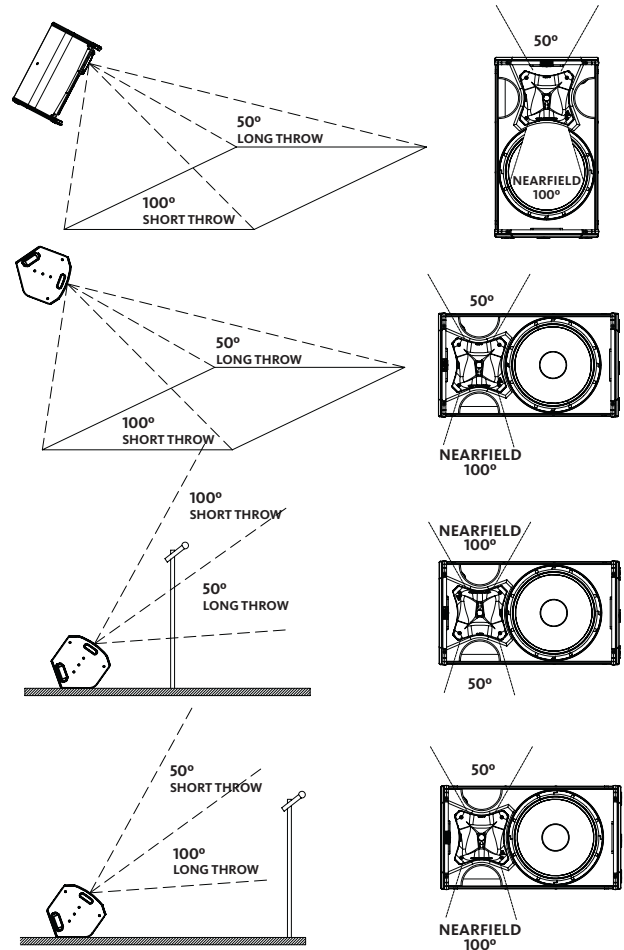

VERTICAL COLUMN-MOUNT
HR-LU + SC-15

VERTICAL TRUSS-MOUNT
HR-LU/GT + SC-15

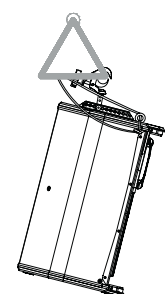
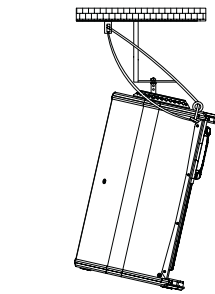

VERTICAL WALL-MOUNT
SP-WHR + SC-15

HORIZONTAL WALL-MOUNT
UB-L + SC-15

