

S10P

10" TWO-WAY PASSIVE
FULL-RANGE SPEAKER SYSTEM

NÍTiD



ASYMMETRICAL
DISPERSION
HORN



VERSATILE FoH PA
& STAGE MONITOR
SYSTEM



DEDICATED CONTROL
PRESETS with external
Amate Audio DSP processors
& processing amplifiers



HIGH RESISTANCE
POLYUREA® FINISH &
PROTECTIVE RUBBER PROFILES



EASY RIGGING &
INSTALLATION ACCESSORIES

Nothing speaks power to form like the Nítid S10. The diminutive, high-performance, aesthetically attractive two-way design takes a new developmental approach different from its progenitor, the N10, resulting in a new driver and asymmetrical horn, all reengineered and restyled to beat the quality expected from a 10" two-way system.

KEY FEATURES

TRANSDUCER TECHNOLOGY

Two-way full range passive loudspeaker system comprising a direct radiating 2-inch voice coil, 10" loudspeaker and one 1.4-inch voice coil diameter, polyester diaphragm compression driver loaded to an asymmetrical rotational horn (50° to 100° x 55° dispersion).

POWER & CONTROL

500 W continuous musical program power handling.

An accurate internal passive crossover achieves optimum performance with high levels of protection for the high frequency driver.

Connectors mounted on an inclined recessed moulded connector plate for improved security and environmental protection.

Double Speakon NL4MP® (input & link).

Dedicated control presets available with Amate Audio LMS series DSP processors and TPD series processing amplifiers.

DESIGN & ACCESSORIES

Recessed ergonomic carry handle for easy handling.

Asymmetric trapezoidal form for PA or floor monitor application.

Exclusive 1.5mm black mesh speaker grille with optimum perforation gradient and attractive appearance.

Multilayer birch plywood cabinet with Polyurea® coating and protective rubber profiles, providing maximum robustness and strength for touring, events production, venue installation and other highly demanding applications.

M8 rigging points for easy flying.

35mm diameter pole mount socket mounted on the bottom side, for a standard tripod.

TECHNICAL FEATURES

Power (musical program)	500 W
Power (r.m.s)	250 W
Nominal Impedance	8Ω
SPL(1W/1m)	96 dB
Maximum SPL(continuous/1m)	123 dB
Maximum SPL(peak/1m)	126 dB
Crossover frequency	1k9 Hz
Frequency Response (-10dB)	55 Hz – 19 kHz
Components	LF - MF 10" woofer (2" voice coil) HF 1.4" polyester diaphragm compression driver
Directivity (-6dB)	50° to 100° x 55°
Directivity factor (Q)	12.6
Directivity Index (DI)	11 dB
Weight	15.3 Kg
Finish	Multilayer birch plywood with high resistant black Polyurea® coating and protective rubber profiles
Dimensions (H x W x D)	543 x 313 x 358 mm
Grille	1.5 mm powder coated steel with black acoustic mesh
Rigging	M8 points
Connectors	1x Speakon NL4MP input / 1x Speakon NL4MP link

DISCOVER NÍTiD

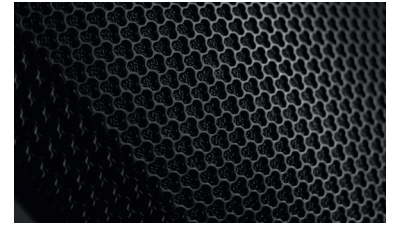

UNIQUE DESIGN

New S-series models build on the success, innovation and best-in-class performance of the original Nítid designs with improved features including a recessed moulded connector plate, more highly stylised form factor and improved robustness of the world's most acoustically transparent pro-audio speaker grille.



THE PERFECT BALANCE

An ongoing programme of research and development ensures that Nítid series loudspeakers continue to achieve the highest levels of output and performance from the most compact sized designs, in an unrivalled synthesis of engineering and aesthetic form.



TOP VIEW



BOTTOM VIEW



SIDE VIEW



FRONT VIEW



REAR VIEW

FREQUENCY RESPONSE 1W/1m

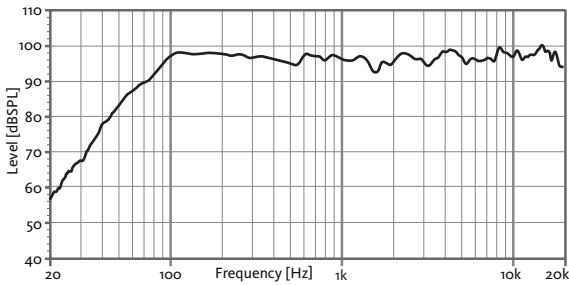

DIRECTIVITY INDEX (DI)

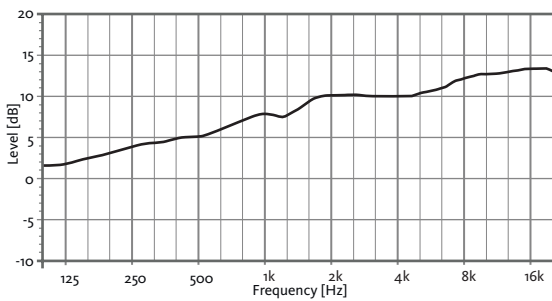

HORIZONTAL & VERTICAL BEAMWIDTH (-6dB point)

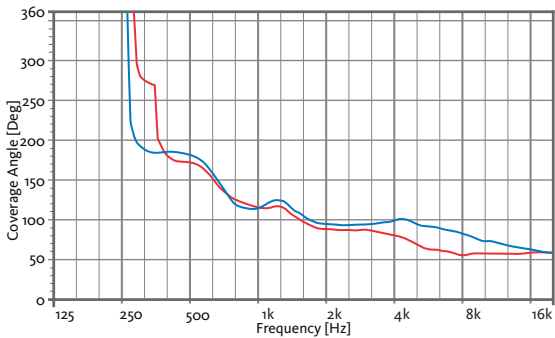

HORIZONTAL VERTICAL

RECOMMENDED PRESETS with external amate audio dsp

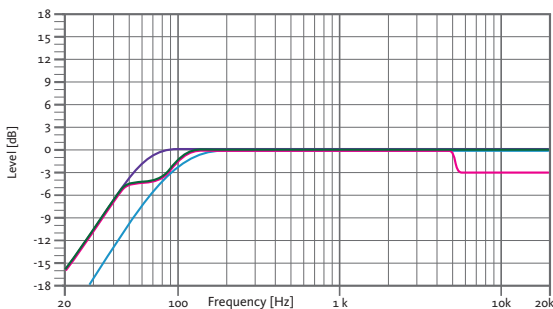

FLAT
Flat response

SPEECH
Vocal use

HPF90
HPF 90 Hz

MONITOR
Stage monitor use

HORIZONTAL COVERAGE

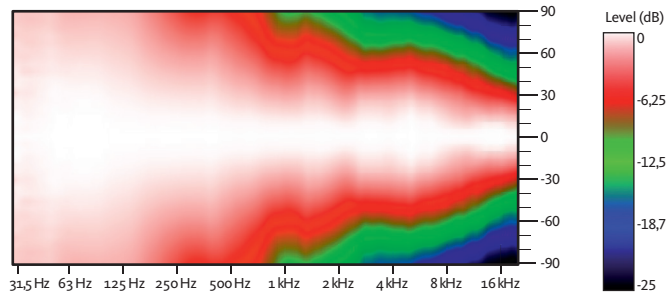

VERTICAL COVERAGE

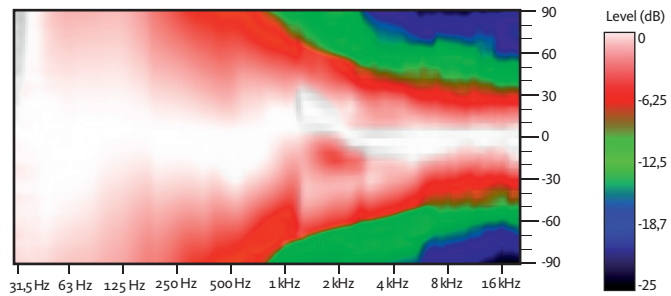

CAD DRAWING SCHEME

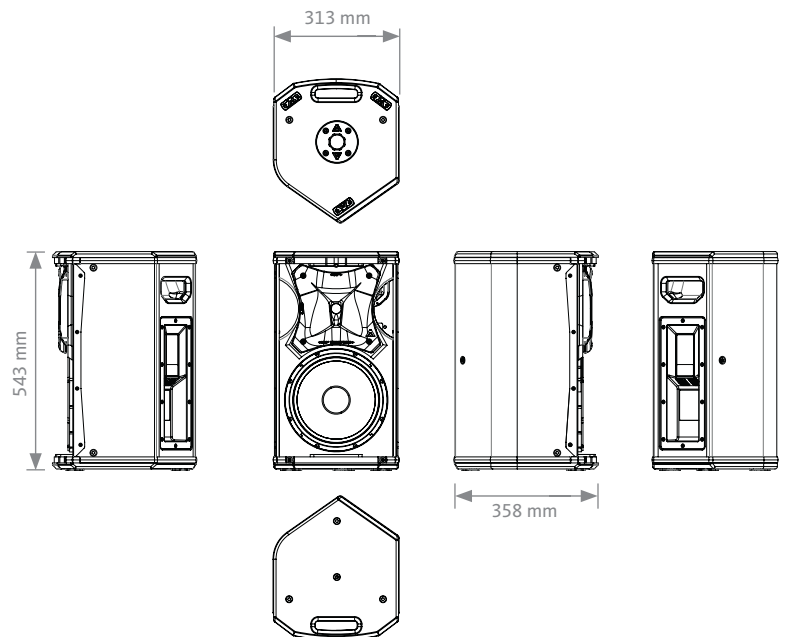

S10P

10" TWO-WAY PASSIVE FULL-RANGE SPEAKER SYSTEM

NÍTiD



ACCESSORIES

FLYING BAR WITH HOOK
HR-LU/GT



WALL-MOUNT BRACKET
SP-WHR



FLYING BAR
HR-LU



WALL MOUNT BRACKET
UB-L

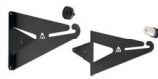

PROTECTION COVER
NC-S10



M8 RIGGING EYEBOLT
ACR-M8



SAFETY SLING
SC-15



FLIGHT CASE
FC-S10
for two units of S10P



TELESCOPIC DISTANCE ROD

SP-CRTL
ø: 35 mm
Length: 55 cm ~ 90 cm
Thread: M20



RECOMMENDED CONFIGURATION

FOR S10P (2 units)

Connect each cabinet output of the amplifier LEFT/RIGHT to each cabinet using two independent wires.

FOR S10P (4 units)

Connect the amplifier's output to the Speaker's input of the first cabinet. Then, make a bridge from the first cabinet to the second one. This configuration allows you to connect up to four cabinets to the same amplifier.

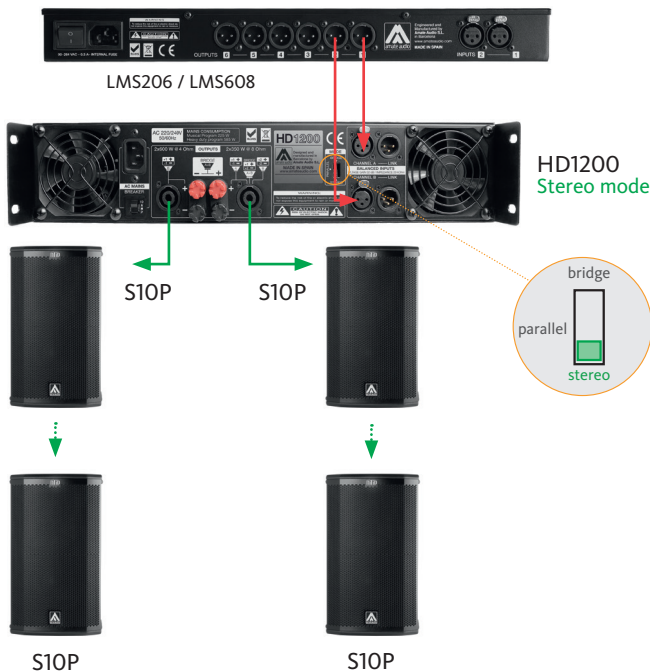

ASYMMETRICAL DISPERSION HORN

It allows to optimize the coverage depending on its position.

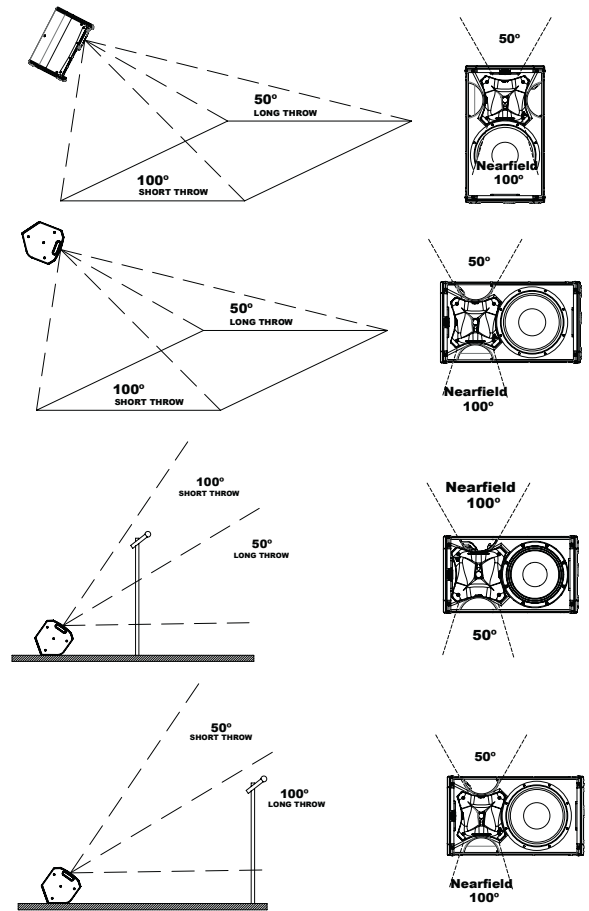

HORIZONTAL WALL-MOUNT
UB-L + SC-15

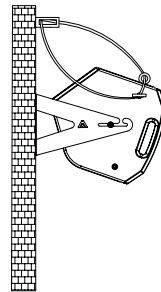

VERTICAL WALL-MOUNT
SP-WHR + SC-15

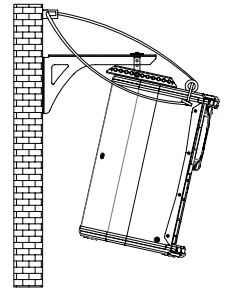

VERTICAL COLUMN-MOUNT
HR-LU + SC-15

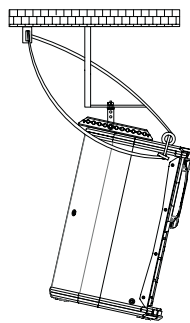

VERTICAL TRUSS-MOUNT
HR-LU/GT + SC-15

