

LIGHT NEODYMIUM
COMPONENTS



CARBON
FIBER
CONE



ASYMMETRICAL
DISPERSION
HORN



MULTIPLE
PRESETS
AVAILABLE



HIGH RESISTANCE
POLYUREA® PAINT



ACCESSORIES FOR
EASY INSTALLATIONS

Full range, high-fidelity signal reproduction with exceptional LF response. The N46 provides high intelligibility, musicality and 125 dB continuous SPL, for unrivalled coverage in all kinds of large and medium auditoria and entertainment venues.

KEY FEATURES

TRANSDUCERS TECHNOLOGY

Two-way full range active speaker system composed by four direct radiating 1,5-inch voice coil, neodymium magnet 6" loudspeakers and one 1,75-inch voice coil diameter, PETP diaphragm, neodymium magnet compression driver loaded to an asymmetrical rotational horn (50° to 100° x 55° dispersion).

AMPLIFICATION

700 W 3rd generation Class D built-in amplifier controlled by a dedicated DSP.

90% efficiency amplifier SMPS (switching mode power supply), allowing maximum power delivery with minimum consumption in an extremely low-weight and reduced size.

Rear connections and control panel with LCD screen to display the different settings, presets, volume and adjustments done by the user. Our SensitiveTouch® capacitive sensor keypad guarantees the reliability of the system even under humidity and extreme weather conditions.

Connectors are placed on an inclined plane to effectively protect them against rain or moisture.

Double PowerCon® (input & link).

DSP & CONTROL

Internal DSP with all necessary signal processing (crossovers, EQ's, delay, limiter, gain control, mute, input dynamic compressor) as well as several useful presets to adjust N46 to different requirements.

The on-screen output power display and the front NITiD backlight help to easy monitor the system. The backlight can be switched on or off, or set to indicate when the system is limiting.

ALC (Adaptative Loudness Compensation) to improve the listening experience when the cabinet is used at low musical levels.

ECO Mode available.

5-band EQ menu with five equalizers.

DESIGN & ACCESSORIES

Ergonomic handle for an easy handling.

1,5mm speaker grille with black mesh, exclusively designed with an optimum perforation gradient and attractive appearance.

Multilayer birch plywood cabinet with Polyurea® coating, offering maximum reliability and strength for touring as well as for high demanding applications.

M8 rigging points for easy flying.

35mm diameter pole mount socket mounted on the bottom side, for a standard tripod.

TECHNICAL FEATURES

Amplifier (program)	600 W (LF) + 100 W (HF) Class D Bi-amplified	
Input Sensitivity	8 dBu – 1.94 V	
Input Impedance	20 kΩ Balanced	
Maximum input level	20 dBu	
Mains	Universal Switch Mode Power Supply 85-265 V / 45-65 Hz	
Average current draw	0.7 A (Heavy duty musical program)	
SPL (1 m)	125 dB continuous musical program, 128 dB peak	
Built-in DSP	48-bit processing unit. Includes factory presets	
AD/DA converters	24 bit – 48 kHz	
Standby mode consumption	< 5 W	
Adjustable delay line	118 ms / 40 m	
Crossover frequency	1k4 Hz	
Frequency response (-10 dB)	50 Hz – 19 kHz	
Components	LF - MF	4x 6" neodymium woofers with carbon fiber cone (1.5" voice coil)
	HF	1.75" PETP diaphragm, neodymium magnet compression driver
Directivity (HxV)	50° to 100° x 55°	
Directivity factor (Q)	12.6	
Directivity Index (DI)	11 dB	
Weight	19 kg	
Dimensions (HxWxD)	1056 x 250 x 258 mm	
Finish	Multilayer birch plywood with high resistant black Polyurea® coating	
Grille	1.5 mm steel with black acoustic mesh	
Rigging	M8 points	
Connectors	1x XLR input / 1x XLR link / 1x AC PowerCon® input / 1x AC PowerCon® link	
Available colors	Black and white	



CONTROL PANEL

Our latest digital signal processing (DSP) is integrated with 3rd generation Class D amplification and operated via our dedicated SensitiveTouch™ keypad technology. With no mechanical components or moving parts, the SensitiveTouch™ capacitive sensor keypad is highly responsive, weatherproof and durable compared with conventional electronic controls and effectively failsafe. With the SensitiveTouch™ keypad and display, you can set-up the N46 in just seconds.



FREQUENCY RESPONSE 1w/1m (FLAT PRESET)

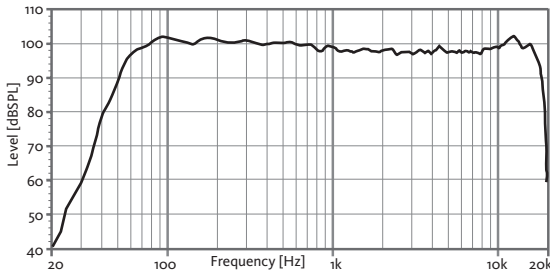

HORIZONTAL COVERAGE

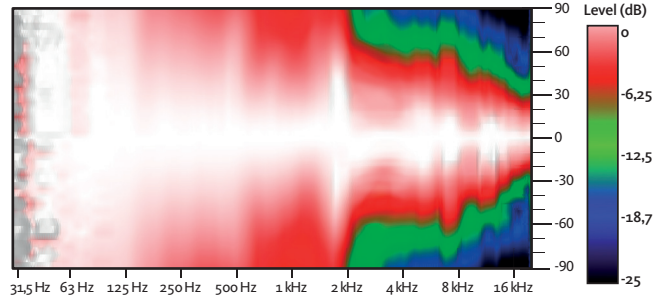

DIRECTIVITY INDEX (DI)

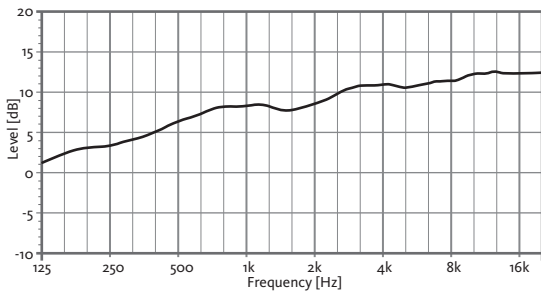

VERTICAL COVERAGE

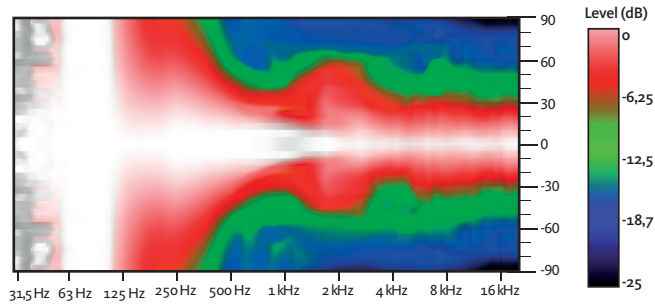

HORIZONTAL & VERTICAL BEAMWIDTH (-6dB point)

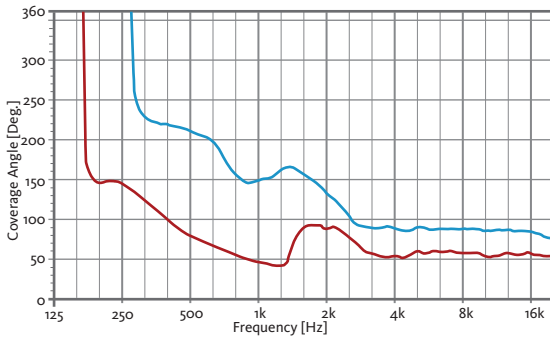

HORIZONTAL VERTICAL

CAD DRAWING SCHEME

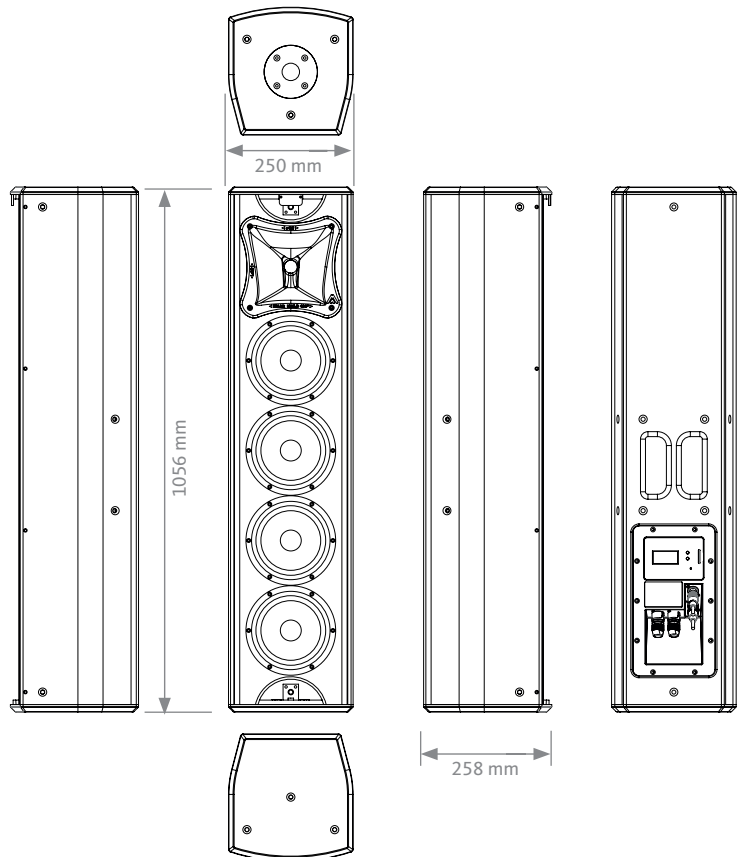

BUILT-IN PRESETS

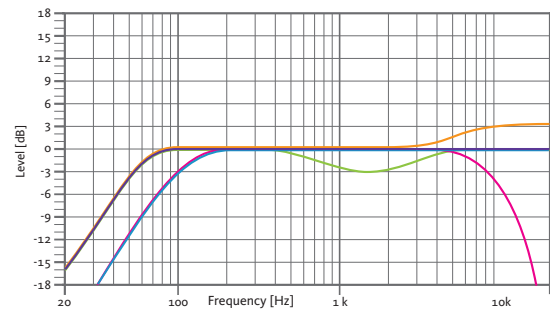

FLAT

Flat response

NEARFIELD

-3 dB mid frequencies (400 Hz – 4 kHz)

LONGTHROW

+3 dB high frequencies

SPEECH

HPF 100 Hz

LPF 8 kHz

XOVER

HPF 100 Hz

ACCESSORIES

TRANSPORT COVER
NC-N46



WALL MOUNT BRACKET
SP-46N



WALL-MOUNT BRACKET
SP-WHR



FLYING BAR WITH HOOK
HR-C/GT



TELESCOPIC DISTANCE ROD
SP-CRTL

ø: 35 mm
Length: 55 cm ~ 90 cm
Thread: M20



FLYING BAR
HR-C



SAFETY SLING
SC-15



M8 RIGGING EYEBOLT
ACR-M8



VERTICAL WALL-MOUNT
SP-46N + SC-15

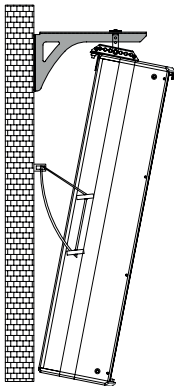
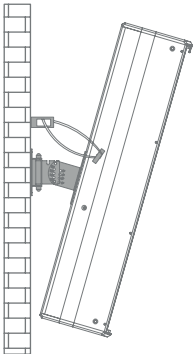

VERTICAL WALL-MOUNT
SP-WHR + SC-15

VERTICAL COLUMN-MOUNT
HR-C + SC-15

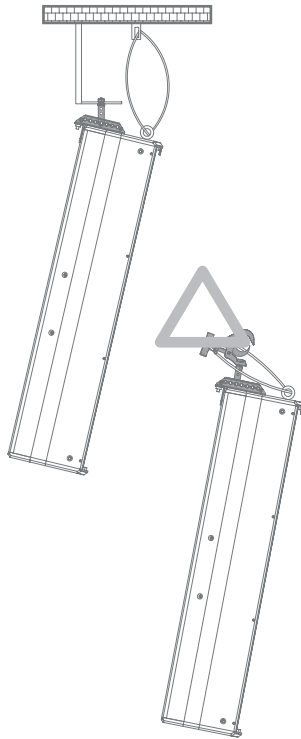

VERTICAL TRUSS-MOUNT
HR-C/GT + SC-15

ASYMMETRICAL DISPERSION HORN

It allows to optimize the coverage depending on its position.

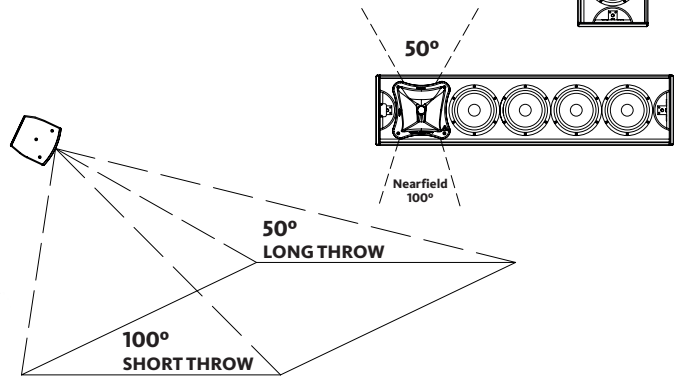
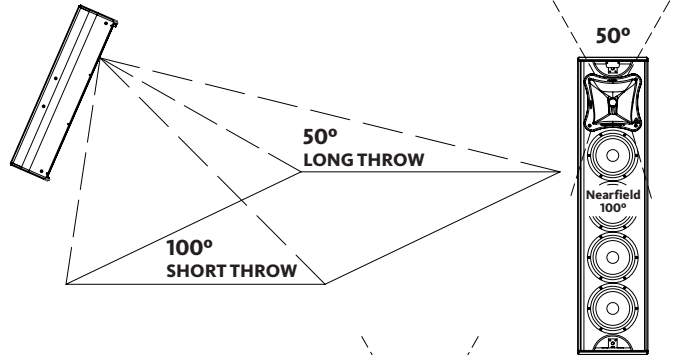

DISCOVER NÍTID

UNIQUE DESIGN

Distinguishing details include the speaker grille, exclusively designed for an attractive appearance, maximum protection, and with **the best performance coefficient in the market, for improved sound quality.** The Polyurea® finish offers durable protection for the birch-ply cabinet, and electronic circuits and controls are smartly protected against moisture. A wide range of accessories is provided for whatever your application is.



THE PERFECT BALANCE

NÍTID series is the culmination of an intensive program of research, development and optimization, to achieve the greatest possible power and performance from the most compact sized cabinet. Every aspect of its form factor has resulted from examination and consideration of optimum acoustic response, ergonomics, construction and appearance.



AMAZING PERFORMANCE

The integrated **'plug & play'** active power and control system includes DSP presets for rapid setup and amazing sound, and the comprehensive control interface includes instantly recallable presets for setting up the **NÍTID** in just a few seconds. The accurate match between transducers, DSP and amplifiers provide a fully optimized system for the most demanding applications.

